

User Guide

INSIGNIA™

HD Radio™ Portable Player - Touchscreen

NS-HD02

HD Radio®



HD Radio™ Portable Player - Touchscreen

Contents

Introduction	2
Important safety instructions	3
Features	5
Using your radio	15
Using the menu to change settings	38
Troubleshooting	45
Checking the battery level	16
Specifications	46
Legal notices	47
90-day limited warranty	49

Introduction

Congratulations on your purchase of an NS-HD02 HD Radio™ Portable Player - Touchscreen. We have designed this product to provide you with access to the full FM spectrum of features that HD Radio Technology offers. This HD Radio is reliable and easy to use. Make sure you read through this guide to familiarize yourself with its features.

Important safety instructions

- 1 Read these instructions.
- 2 Keep these instructions.
- 3 Heed all warnings.
- 4 Follow all instructions.
- 5 Do not use this apparatus near water.
- 6 Clean only with a dry cloth.
- 7 Do not block any ventilation openings. Install in accordance with the manufacturer's instructions.
- 8 Do not install near any heat sources such as radiators, heat registers, stoves, or other apparatus (including amplifiers) that produce heat.
- 9 Protect the USB cord from being walked on or pinched, particularly at plugs, convenience receptacles, and the point where they exit from the apparatus.
- 10 Only use attachments/accessories specified by the manufacturer.
- 11 Use only with the cart, stand, tripod, bracket, or table specified by the manufacturer, or sold with the apparatus. When a cart is used, use caution when moving the cart/apparatus combination to avoid injury from tip-over.
- 12 Refer all servicing to qualified service personnel. Servicing is required when the apparatus has been damaged in any way, such as power-supply cord or plug is damaged, liquid has been spilled or objects have fallen into the apparatus, the apparatus has been exposed to rain or moisture, does not operate normally, or has been dropped.
- 13 To reduce the risk of fire or electric shock, do not expose this device to rain, moisture, dripping, or splashing, and no objects filled with liquids, such as vases, shall be placed on it.



Additional safety information

- Be careful when you use your radio with the USB plug pulled out. The sharp USB connection plug may cause injury.
- Observe local laws regarding using earphones while driving a motor vehicle. Some locales allow only one ear to be covered by an earphone. Using the earphones while walking or jogging on a road or on a crosswalk can lead to a serious accident.
- Do not leave your radio in temperatures above 104°F (40°C), such as in a sauna or a parked car.
- Using earphones or headphones for an extended time may cause serious damage to your hearing. If you are exposed to sound louder than 85dB for extended time, you may adversely affect your hearing. The louder the sound is, the more seriously damaged your hearing may be (an ordinary conversation is between 50dB to 60dB and road noise is approximately 80dB).
- You are strongly advised to set the volume level to medium (the medium level is usually less than 2/3 of the maximum).
- If you hear a ringing in your ear(s), lower the volume or stop using the earphones or headphones.
- Do not place your radio near magnetic objects.

Features

- 20 station presets
- 10 Song List Memos (Bookmark)
- Artist Experience (for example, album art)
- 3.5 mm output jack
- Touch-screen LCD
- Built-in lithium-ion rechargeable battery
- USB charging
- Live Pause (lets you pause and replay music)

Package contents

- HD Radio Portable Touchscreen Player
- Armband
- Earphones
- USB cable for charging the battery
- User Guide
- Quick Setup Guide

Front

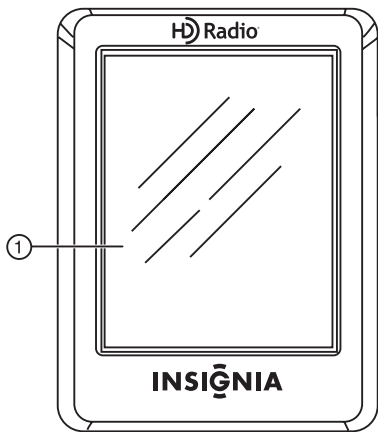

#	Item	Description
1	LCD	Display and touchscreen user interface.

Bottom

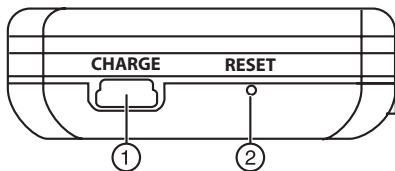

#	Item	Description
1	CHARGE	Connect the included USB cable into this port and into a USB port on a computer to charge the built-in battery or to power your radio. For more information, see "Charging the battery" on page 16.
2	RESET	If your radio stops responding to button presses, press to reset your radio.

Sides

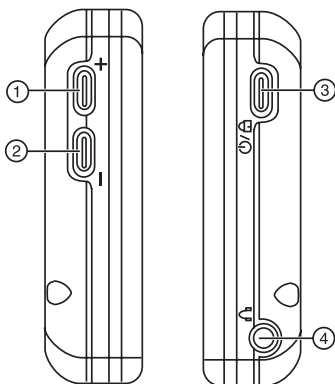

#	Item	Description
1	+ (Volume)	Press to increase the volume. For more information, see "Adjusting the volume" on page 25.
2	- (Volume)	Press to decrease the volume. For more information, see "Adjusting the volume" on page 25.
3	 (Power/Lock)	Press and hold to turn your radio on or off. For more information, see "Turning your radio on or off" on page 23. Press to lock the touch screen. Press again to unlock the touch screen. For more information, see "Unlocking and locking the touch screen" on page 37.
4	Earphone jack	Plug the included earphones into this jack.

LCD information

Changing the buttons

You can change and choose the group of buttons you want using your finger tip by sliding it from left to right or right to left in the button area. If a button can't be used in the selected mode, it will be grayed out.

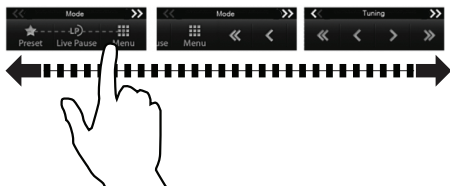

Analog (FM) radio mode



#	Item	Description
1	Radio band	The radio band that you are listening to now.

2	Signal strength	A bar graph showing strength of the signal.
3	Frequency bar	An analog display of the current frequency.
4	Preset button	Press to save a station preset.
5	Preset number	The number of the current preset.
6	Battery charge	The current level of the battery charge.
7	Seek mode	Indicates the current seek mode.
8	Frequency	A digital display of the current frequency.
9	Menu button	Press to open the setup menu.
10	Live Pause button	Press to go to Live Pause mode (to temporarily record and playback music).

HD Radio mode - Artist Experience display (default screen)



#	Item	Description
1	HD Radio indicator	Indicates you are listening to HD Radio.
2	Radio band	The radio band that you are listening to now.

3	Signal strength	A bar graph showing strength of the signal.
4	Multicast channel number	The Multicast channel number of the current station.
5	Station name	The name of the current radio station.
6	Artist Experience display	Shows the Artist Experience image of the current album (if available).
7	Song Title	The song title of the current selection.
8	Guide button	Press to enter Guide mode.
9	Preset number	The number of the current preset.
10	Battery charge	The current level of the battery charge.
11	Seek mode	Indicates the current seek mode.
12	Artist	The artist name of the currently selected album.
13	Album name	The name of the currently selected album.
14	Frequency	The frequency of the current station.
15	Memo button	Press to enter Memo mode (to mark a favorite song in HD Radio mode).

RBDS mode (default screen)

#	Item	Description
1	RBDS indicator	Indicates that you are listening to RBDS (Radio Broadcast Data System) which transmits encoded analog information with the FM radio signal.
2	Radio band	The radio band that you are listening to now.
3	Signal strength	A bar graph showing strength of the signal.
4	RBDS text data	Displays RBDS text data.
5	Frequency bar	An analog display of the current frequency.
6	Seek down button	Press to seek to a station on a lower frequency.
7	Tune down button	Press to tune the radio to a lower frequency.
8	Preset number	The number of the current preset.
9	Battery charge	The current level of the battery charge.
10	Seek mode	Indicates the current seek mode.

11	Frequency/Station name	Shows the frequency and station name of the current selection.
12	Seek up button	Press to seek to a station on a higher frequency.
13	Tune up button	Press to tune the radio to a higher frequency.

Menu buttons

Press these buttons to change modes from the default mode.

Default mode

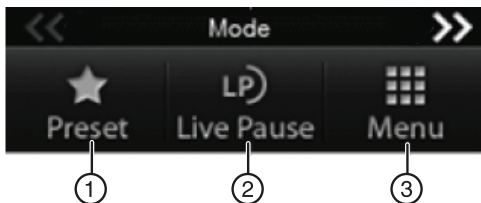

Live Pause mode

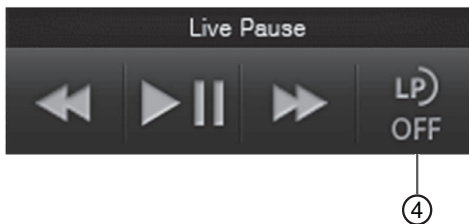

#	Description
1	Press to change to Preset mode (to save a station preset).
2	Press to change to Live Pause mode (to pause and play back music).
3	Press to change to Menu mode.
4	Press to change to default mode (in Live Pause mode).

Tune buttons

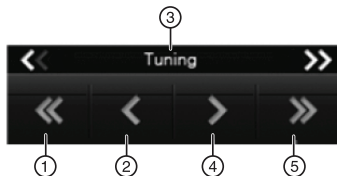

#	Item	Description
1	Seek down	Press to seek to a radio station on a lower frequency.
2	Tune down	Press to tune to a radio station on a lower frequency.
3	Mode position	Indicates the name and position of the current mode.
4	Tune up	Press to tune to a radio station on a higher frequency.
5	Seek up	Press to seek to a radio station on a higher frequency.

Live Pause control buttons

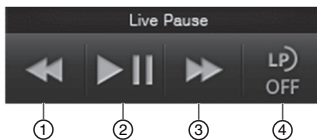

#	Item	Description
1	Rewind	Press to rewind Live Pause.
2	Play/Pause	Press to play a song saved in Live Pause.
3	Fast Forward	Press to fast forward Live Pause.
4	Live Pause off	Press to turn off Live Pause.

Guide/Memo buttons

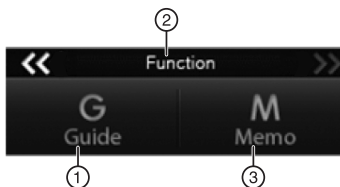

#	Item	Description
1	Guide	Press to enter Guide mode.
2	Mode	Indicates the current mode.
3	Favorite song memo	Press to enter a favorite song memo in HD Radio mode.

Using your radio

Using the buttons

Mode button: Press to change the mode. You can select Preset, Live Pause, and Menu mode.

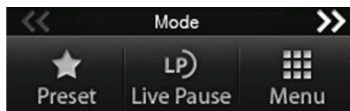

Default mode

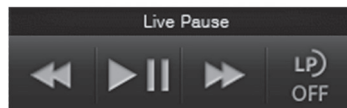

Live Pause mode

Tune button: Press to change the radio channel frequency. You can tune up or down manually and use the seek feature to seek an available frequency channel automatically.

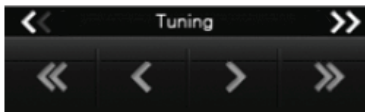

Live Pause control button: Press to use the Live Pause feature. You can use FF, Play/Pause, and REW.

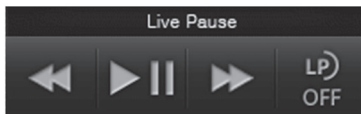

Guide/Memo button: When in HD Radio mode, press to enter Guide mode or select a favorite song memo.

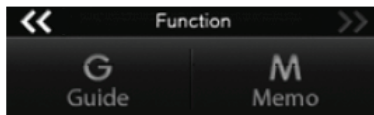

Checking the battery level

If the battery indicator on the LCD looks like this: , the battery level is low. Charge the battery by following the instructions in "Charging the battery" below.

Charging the battery

Your radio has a built-in battery that you charge from a USB port on a computer.

To charge the battery:

- 1 Connect the included USB cable to a USB port on a computer, then connect the other end of the cable to the **CHARGE** port on your radio.

While the battery is charging, the following indicator appears on the top right of the screen:



When charging is complete, the following indicator appears on the top right of the screen:



- 2 Disconnect your radio from the computer.

Note

Do not charge your battery for long periods of time (for example, all day). Excessive charging may shorten the battery's life.

Using the armband

To use the armband:

- 1 Slide your HD Radio Portable Player into the armband pocket.



- 2** Wrap the armband around your upper arm with the radio facing out, then slide the strap through the loop and pull the strap to tighten it.



- 3** Fold the strap back over itself so it sticks to the velcro strip and holds the armband in place.



When the armband is securely in place, your radio controls are easy to access.



Understanding radio modes

Your radio has three radio modes: Analog (FM), HD Radio, and RBDS (Radio Broadcast Data System).

The three radio modes are automatically changed when the receiving frequency is changed.

Analog (FM) mode

Analog (FM) mode is the standard mode that has been in use for many years. The FM radio signal is an analog signal. When receiving an FM signal, the “FM” icon appears on the display.



HD Radio mode

HD Radio mode is the new digital mode for FM. Many HD Radio stations have several sub-channels called “multicast channels.” When receiving an HD Radio signal, the “HD” icon and the channel number appear on the display.

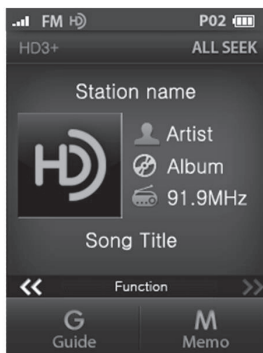

Artist Experience display

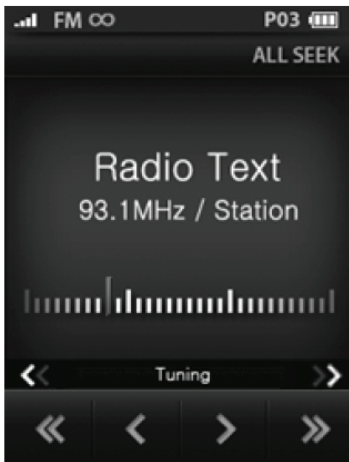

RBDS mode

RBDS (Radio Broadcast Data System) mode provides additional functionality to FM radio reception by transmitting encoded analog information with the FM radio signal. This signal is decoded by an RBDS receiver and can provide a range of informational features including the station's name. The RBDS text is usually centered. When the text fills the display, it begins scrolling. When receiving an RBDS signal, the "RBDS" icon appears on the display.



Turning your radio on or off

To turn your radio on or off:

- Press / . Your radio turns on and the following message appears on the display:



Then one of the following screens appears (depending on the radio station):

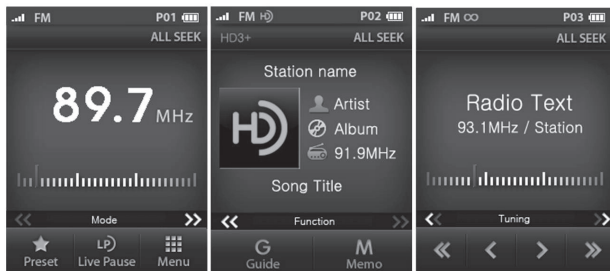

Analog (FM) mode

HD Radio mode

RBDS mode

- To turn off your radio, press  for about one second. The following message appears on the display:



Adjusting the volume

Caution

Listening to your radio with the volume set too loud or using earphones for extended periods of time can damage your hearing. You should set the volume level to medium (the medium level is usually less than 2/3 of the maximum).

To adjust the volume:

- Press the + button to increase the volume or press the – button to decrease the volume. The volume indicator on the display shows the increase or decrease. The volume indicator disappears after one second.



Automatically tuning to a station

To automatically tune to a station in analog (FM) mode:

- Press **»»** to automatically tune to the next higher radio station. If the search reaches the top of the radio band, your radio goes to the bottom of the band and continues searching.
- Press **««** to automatically tune to the next lower radio station. If the search reaches the bottom of the radio band, your radio goes to the top of the band and continues searching.

To automatically tune to a station in HD Radio mode:

- Press **»»** to automatically tune to the next higher HD Radio station.
In ALL SEEK or HD SEEK mode, each time you press **»»**, your radio goes to the next higher multicast channel of the current station. When your radio reaches the highest multicast channel, it goes to the next higher station.
- Press **««** to automatically tune to the next lower HD Radio station.

In ALL SEEK or HD SEEK mode, each time you press , your radio goes to the next lower multicast channel of the current station. When your radio reaches the lowest multicast channel, it goes to the next lower station (analog or HD).

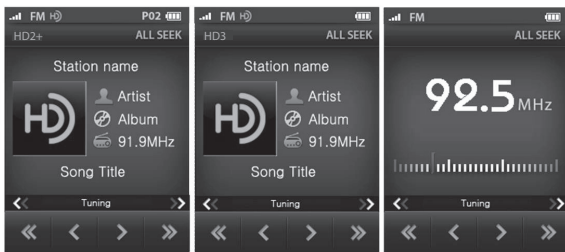



The + after *HD2* indicates at least one higher multicast channel.

The absence of a + after *HD3* indicates that 3 is the highest multicast channel.

The next higher or lower station may be a standard analog (FM) station.





To automatically tune to a radio station in RBDS mode:

- In ALL SEEK or HD SEEK mode, press  to automatically tune to the next higher station.
- Press  to automatically tune to the next lower radio station. If the search reaches the bottom of the radio band, your radio goes to the top of the band and continues searching.





Manually tuning to a frequency

When you manually tune, your radio goes to the next or previous frequency regardless of whether a station is broadcasting on the frequency.

To manually tune to a frequency in analog (FM) mode or RBDS mode:

- Press  for less than one second. Your radio goes to the next higher frequency. Each press of the button changes the frequency by 0.2 MHz.
- Press  for less than one second. Your radio goes to the next lower frequency. Each press of the button changes the frequency by 0.2 MHz.
- Press and hold  or  to fast-forward or fast-reverse through frequencies.

To manually tune to a frequency in HD Radio mode:

- Press  for less than one second. Your radio goes to the next higher multicast channel for the current station. When your radio reaches the highest multicast channel, it goes to the the next higher frequency.
- Press  for less than one second. Your radio goes to the lower multicast channel for the current station. When your radio reaches the lowest multicast channel, it goes to the the next lower frequency.
- Press and hold  or  to fast-forward or fast-reverse through multicast channels and frequencies.

Setting a preset station

To set a preset station:

- 1 Tune to the station you want to make a preset.
- 2 Press the **Preset** button.
- 3 Press the Preset number you want to assign to this station, then press **Store**.



- 4 Select **YES** to store the preset or **NO** to exit Preset mode.



Note

After one second, the pop-up disappears and the preset number of the current station is displayed at the top right of the screen.

- When you press one of the presets on the screen, it is highlighted. Press the preset again or press the **Select** button to go to the preset station.



- Press the **Return** button to exit without storing or calling the preset.

Note





You can store as many as 20 presets.

Using Live Pause

This radio is capable of storing about 15 minutes of audio from the channel that you are listening to for later playback. You can use Live Pause in any of the radio modes, FM, HD Radio, or RBDS. When you enter Live Pause, the icon is displayed and the radio is paused (with no audio output).

To use Live Pause:

- Slide the buttons along the bottom of the screen to access the Live Pause button.

- 2 Press  to enter Live Pause mode. The  appears in the upper right corner of the screen, memory begins to fill, and the audio is muted. The progress bar fills from left to right, indicating how much of the Live Pause memory has been used.
- 3 Press  to exit Live Pause mode and return to live FM radio mode. The Live Pause mode icon  disappears and the memory is cleared.



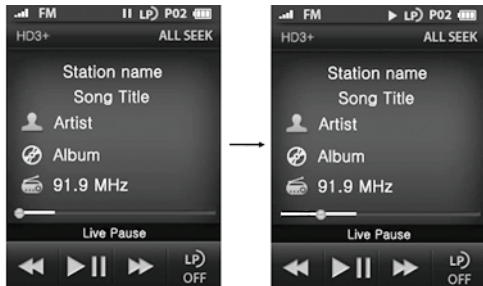

To control Live Pause:

- Press Play **▶||** to listen to the stored audio. The play position indicator [indicator icon] moves slowly to the right. Memory is completely full after about 15 minutes. When the memory is full (after about 15 minutes), “Buffer Full” is displayed, play is stopped, and audio is muted.



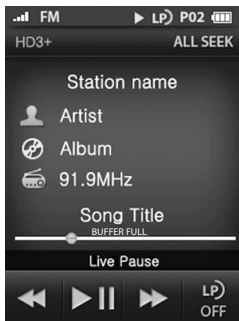

- Press the **▶||** button to pause the radio. The status icon changes to **||**.
- Press the **◀** button to rewind through Live Pause memory. The play position indicator ● moves to the left and shows the current playback position in the Live Pause memory.

- Press the  button to fast forward through Live Pause memory. The play position indicator  moves to the right and shows the current playback position in the Live Pause memory.



Using the program guide

To use the program guide:

- In normal display mode, press  to switch to program guide display mode in HD Radio mode.
- In program guide display mode, press  to switch to normal display mode in HD Radio mode.

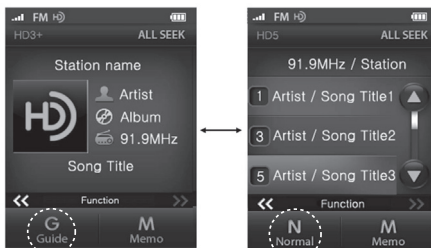

Using the Favorite Song Memo (Bookmark)

The total number of artist and song titles you can store in HD Radio mode is 10.

To set the song list memo (Bookmark):

- 1 Scan to an HD Radio station.
- 2 While you are listening, press **M Memo** to store the artist and song title of the song you like.

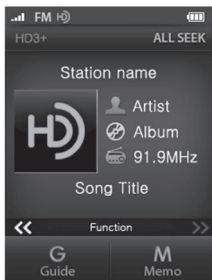

- 3 The song storage location and "Song Saved" is shown.



After one second, the number of stored songs and available songs is shown.

- 4 If you try to store a song when the memo list is full, the message, "Memory is full" is shown (see "Displaying the song list" on page 42 for more information.)



- 5 Press **Menu**, then **Favorite Song Memo** to see the stored list.

Displaying the Artist Experience image

If the station you are listening to supports the Artist Experience display, the album cover of the song currently being played is shown on the screen. This function is available in HD Radio mode only. If Artist Experience is not available, the HD Radio logo is displayed.

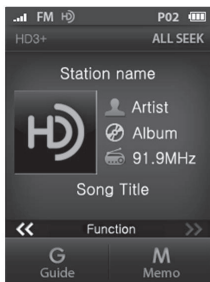

Normal album display



Full album display

The normal album display changes to the full album display after five seconds. With the full album display shown, if you touch the screen, **Artist/Song Title** changes to the **Guide/Memo** buttons, as shown below.

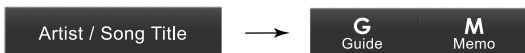

Unlocking and locking the touch screen

Note

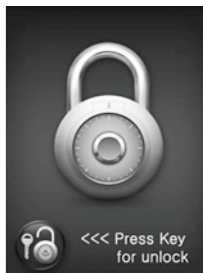

The touch screen is automatically locked when the backlighting is off.



Locking display status

To unlock or lock the touch screen:

When the backlighting is off the screen is locked.

- 1 Press the  button to show the locking display status.
- 2 Press  to unlock the screen and go to operating status.
Operating display status is the normal operating status where the touch screen and key buttons work.
- 3 Press  again to lock your radio.
- 4 If there is no key input or screen touch for three seconds (or the time you set in the menu) the backlight automatically turns off. The screen dims in preparation to lock. If there is any key input or the screen is touched while the screen is dim, the backlight turns on.

Using the menu to change settings

To use the menu to change settings:

- 1 Press  to enter menu mode. The *Main* menu opens.





- 2 Press an item on the main menu to enter that item.
- 3 Change the settings you want.
- 4 Press  to return to radio mode.

Adjusting the LCD

To adjust the LCD:

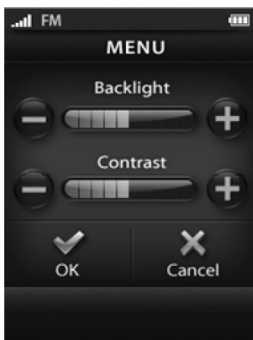
- 1 With the *Main* menu open, press **LCD control**. The *LCD control* screen opens.



- 2 Press **+** or **-** to adjust the backlight and contrast of the LCD.
- 3 Press  to save the setting.
- OR -
Press  to cancel the settings and return to the *Main* menu.

Adjusting the backlight time

To adjust the backlight time:

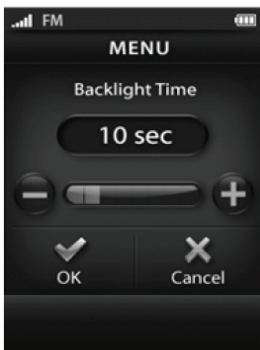

- 1 With the *Main* menu open, press **Backlight time**. The *Backlight Time* screen opens.



- 2 Press **+** or **-** to adjust the backlight time. Options include **5 sec**, **10 sec**, **15 sec**, **20 sec**, **30 sec**, **45 sec**, **1 min**, and **Always on**.

Note

We do not recommend setting the LCD to Always on, because the screen life is shortened by using that setting.



- 3 Press  to save the setting.
- OR -
Press  to cancel the settings and return to the *Main* menu.

Setting the seek type

To set the seek type:

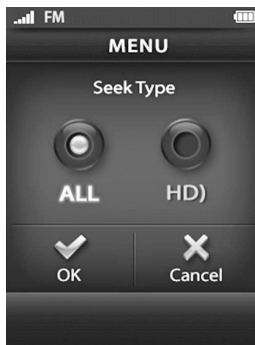
- 1 With the *Main* menu open, press **Seek type**. The *Seek Type* screen opens.







- 2 Press **ALL** or **HD)** to set the seek type. If you select **ALL**, your radio searches through all stations. If you select **HD)**, your radio only searches HD Radio stations.
- 3 Press  to save the setting.
- OR -
Press  to cancel the settings and return to the *Main* menu.

Displaying the song list

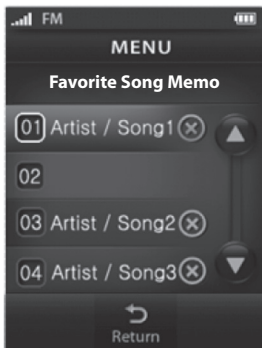
To display the song list:

- With the *Main* menu open, press **Favorite Song Memo**. The *Favorite Song Memo* screen opens.





- Press  to go down the list.
- Press  to go up the list.
- Press  to delete an item from the list.

Displaying the software version

To display the software version:

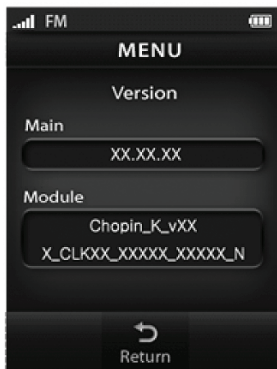
- 1 With the *Main* menu open, press **Version**. The *Version* screen opens.





- 2 Press  to return to the *Main* menu.

Resetting options to factory defaults

To reset options to factory defaults:

- 1 With the *Main* menu open, press **Factory default**. The *Factory default* screen opens.



- 2 Press  to reset all settings to factory default. "Please wait..." appears on the screen and the settings return to factory default.
- 3 Press  to cancel and return to the *Main* menu.

Troubleshooting

Do not try to repair your radio yourself. Refer all servicing to qualified repair personnel.

Symptoms	Possible causes and solutions
The radio does not turn on	Battery is dead. Recharge the battery. For more information, see "Charging the battery" on page 16.
	There is moisture or condensation in your radio. Let your radio warm up to room temperature for 60 minutes, then try again.
Poor radio reception	The earphones work as an antenna and are not connected completely. Make sure that the earphones are connected correctly, or pull out the earphones, then plug them into the jack again.
Intermittent sound	The earphones are not connected completely. Make sure that the earphones are plugged in completely and securely.
No sound	The earphones are not connected. Make sure that the earphones are plugged in completely and securely.
	The volume control may be turned down. Increase the volume.
	In Live Pause mode, press Play or exit Live Pause mode to return to live FM mode.

Symptoms	Possible causes and solutions
Battery will not charge	The USB cable is not connected to your radio or a computer. Make sure that the USB cable is connected to your radio and a USB port on a computer.
	The USB port on the computer may not be working. Try a different USB port.
	The computer connected to your radio is not turned on. Turn on the computer.
Your radio stops working	Turn the power off and back on again, then start over. If powering off and back on again fails, or if your radio stops working, insert the end of a bent paper clip into the reset hole on the side of your radio.

Specifications

Frequency range	87.5 MHz - 107.9 MHz (200 KHz steps)
Station presets	FM: 20
External connection	3.5 mm stereo
Volume	15 levels
Display	2.4 in TFT LCD display (240 × 320 pixels)
Audio output	100mV (Peak-to-peak)
Input	5V DC 500mA
Battery	3.7V 750mAh Li-ion
Dimensions W × H × W	2.1 × 2.8 × 0.7 inches (5.2 × 7 × 1.8 cm)

Legal notices

FCC information

This equipment has been tested and found to comply with the limits for a Class B digital device, pursuant to part 15 of FCC Rules. These limits are designed to provide reasonable protection against harmful interference in a residential installation. This equipment generates, uses and can radiate radio frequency energy and, if not installed and used in accordance with the instructions, may cause harmful interference to radio communications. However, there is no guarantee that interference will not occur in a particular installation. If this equipment does cause harmful interference to radio or television reception, which can be determined by turning the equipment off and on, the user is encouraged to try to correct the interference by one more of the following measures:

- Reorient or relocate the receiving antenna.
- Increase the separation between the equipment and receiver.
- Connect the equipment into an outlet on a circuit different from that to which the receiver is connected.
- Consult the dealer or an experienced radio/TV technician for help.

FCC warning

Any change or modifications not expressly approved by the manufacturer could void the user's authority to operate the equipment.

Canada ICES-003 statement

This Class B digital apparatus complies with Canadian ICES-003.
Cet appareil numérique de la Classe B est conforme à la norme NMB-003 du Canada.

Trademark statement

HD Radio™ Technology Manufactured Under License From iBiquity Digital Corp. U.S. and Foreign Patents. HD Radio™ and the HD and HD Radio logos are the proprietary trademarks of iBiquity Digital Corporation.

90-day limited warranty

Insignia Products ("Insignia") warrants to you, the original purchaser of this new NS-HD02 ("Product"), that the Product shall be free of defects in the original manufacture of the material or workmanship for a period of 90 days from the date of your purchase of the Product ("Warranty Period"). This Product must be purchased from an authorized dealer of Insignia brand products and packaged with this warranty statement. This warranty does not cover refurbished Product. If you notify Insignia during the Warranty Period of a defect covered by this warranty that requires service, terms of this warranty apply.

How long does the coverage last?

The Warranty Period lasts for 90 days from the date you purchased the Product. The purchase date is printed on the receipt you received with the Product.

What does this warranty cover?

During the Warranty Period, if the original manufacture of the material or workmanship of the Product is determined to be defective by an authorized Insignia repair center or store personnel, Insignia will (at its sole option): (1) repair the Product with new or rebuilt parts; or (2) replace the Product at no charge with new or rebuilt comparable products or parts. Products and parts replaced under this warranty become the property of Insignia and are not returned to you. If service of Products or parts are required after the Warranty Period expires, you must pay all labor and parts charges. This warranty lasts as long as you own your Insignia Product during the Warranty Period. Warranty coverage terminates if you sell or otherwise transfer the Product.

How to obtain warranty service?

If you purchased the Product at a retail store location, take your original receipt and the Product to the store you purchased it from. Make sure that you place the Product in its original packaging or packaging that provides the same amount of protection as the original packaging. If you purchased the Product from an online web site, mail your original receipt and the Product to the address listed on the web site. Make sure that you put the Product in its original packaging or packaging that provides the same amount of protection as the original packaging.

To obtain in-home warranty service for a television with a screen 25 inches or larger, call 1-888-BESTBUY. Call agents will diagnose and correct the issue over the phone or will have an Insignia-approved repair person dispatched to your home.

Where is the warranty valid?

This warranty is valid only to the original purchaser of the product in the United States, Canada, and Mexico.

What does the warranty not cover?

This warranty does not cover:

- Customer instruction
- Installation
- Set up adjustments
- Cosmetic damage
- Damage due to acts of God, such as lightning strikes
- Accident
- Misuse
- Abuse
- Negligence
- Commercial use
- Modification of any part of the Product, including the antenna
- Plasma display panel damaged by static (non-moving) images applied for lengthy periods (burn-in).

This warranty also does not cover:

- Damage due to incorrect operation or maintenance
- Connection to an incorrect voltage supply
- Attempted repair by anyone other than a facility authorized by Insignia to service the Product
- Products sold as is or with all faults
- Consumables, such as fuses or batteries
- Products where the factory applied serial number has been altered or removed

REPAIR REPLACEMENT AS PROVIDED UNDER THIS WARRANTY IS YOUR EXCLUSIVE REMEDY. INSIGNIA SHALL NOT BE LIABLE FOR ANY INCIDENTAL OR CONSEQUENTIAL DAMAGES FOR THE BREACH OF ANY EXPRESS OR IMPLIED WARRANTY ON THIS PRODUCT, INCLUDING, BUT NOT LIMITED TO, LOST DATA, LOSS OF USE OF YOUR PRODUCT, LOST BUSINESS OR LOST PROFITS. INSIGNIA PRODUCTS MAKES NO OTHER EXPRESS WARRANTIES WITH RESPECT TO THE PRODUCT, ALL EXPRESS AND IMPLIED WARRANTIES FOR THE PRODUCT, INCLUDING, BUT NOT LIMITED TO, ANY IMPLIED WARRANTIES OF AND CONDITIONS OF MERCHANTABILITY AND FITNESS FOR A PARTICULAR PURPOSE, ARE LIMITED IN DURATION TO THE WARRANTY PERIOD SET FORTH ABOVE AND NO WARRANTIES, WHETHER EXPRESS OR IMPLIED, WILL APPLY AFTER THE WARRANTY PERIOD. SOME STATES, PROVINCES AND JURISDICTIONS DO NOT ALLOW LIMITATIONS ON HOW LONG AN IMPLIED WARRANTY LASTS, SO THE ABOVE LIMITATION MAY NOT APPLY TO YOU. THIS WARRANTY GIVES YOU SPECIFIC LEGAL RIGHTS, AND YOU MAY ALSO HAVE OTHER RIGHTS, WHICH VARY FROM STATE TO STATE OR PROVINCE TO PROVINCE.

Contact Insignia:

For customer service please call 1-877-467-4289

www.insigniaproducts.com

Distributed by Best Buy Purchasing, LLC

7601 Penn Avenue South, Richfield, Minnesota, U.S.A. 55423-3645

© 2011 BBY Solutions, Inc.

All rights reserved. INSIGNIA is a trademark of BBY Solutions, Inc. Registered in some countries. All other products and brand names are trademarks of their respective owners.

HD Radio™ Technology Manufactured Under License From iBiquity Digital Corp. U.S. and Foreign Patents. HD Radio™ and the HD and HD Radio logos are the proprietary trademarks of iBiquity Digital Corporation.

INSIGNIA™

www.insigniaproducts.com (877) 467-4289

Distributed by Best Buy Purchasing, LLC
7601 Penn Avenue South, Richfield, MN USA 55423-3645

© 2011 BBY Solutions, Inc.

All rights reserved. INSIGNIA is a trademark of BBY Solutions, Inc. Registered in some countries.
All other products and brand names are trademarks of their respective owners.

ENGLISH
11-0133

HD Radio™ Technology Manufactured Under License From iBiquity Digital Corp. U.S. and Foreign Patents. HD Radio™ and the HD and HD Radio logos are the proprietary trademarks of iBiquity Digital Corporation.